

EIBOR Medical

Needle Holders	1-2	Curettes	15
Scissors	3-6	Speculums	16
Tongue Depressor	6	Scalpel Handles	17
Dressing Forceps	7	Retractors	18
Tissue Forceps	7-8	Hooks & Knife	19
Splinter Forceps	9	Probes	19, 25
Jewelers Forceps	9	Podiatry Tools	20
Aural Dressing Forceps	9-10	Suction Tubes	21
Uterine Forceps	10, 11, 12	Biopsy Forceps	22
Cilia Forceps	10	Dilators	22-23
Tubing Clamp/Forceps	11	Towel Clamp / Forceps	23
Sponge Holding Forceps	11	Laryngeal Mirrors	24
Sterilizing Forceps	11	Hand Drill	24
Septum Elevators	12	Wire Saw	24
Obstetrical Forceps	12	Stethoscopes	25
Bulldog Clamps	13	Laryngoscopes	26
Artery Forceps	13-14	Colour Coded Instruments	27



SU 100 - 001
Mayo Hegar

- 1** 14.0 cm
- 2** 16.0 cm
- 3** 18.0 cm
- 4** 20.0 cm



SU 100 - 002
Olsen Hegar

- 1** 14.0 cm
- 2** 18.0 cm



SU 100 - 003
Derf

- 1** 12.5 cm



SU 100 - 004
Webster

- 1** 12.5 cm

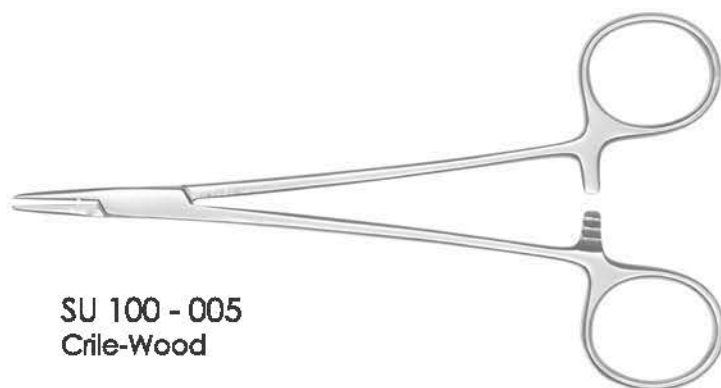

SU 100 - 005
Crile-Wood

- 1** 15.0 cm



SU 100 - 006
Gillies

- 1** 16.0 cm

NEEDLE HOLDERS

EIBOR Medical



SU 100 - 007
Baumgartner

1 12.5 cm

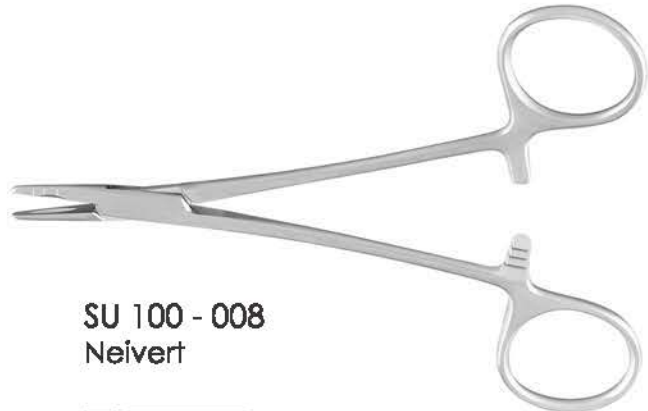

SU 100 - 008
Neivert

1 12.5 cm



SU 100 - 009
Converse

1 12.5 cm

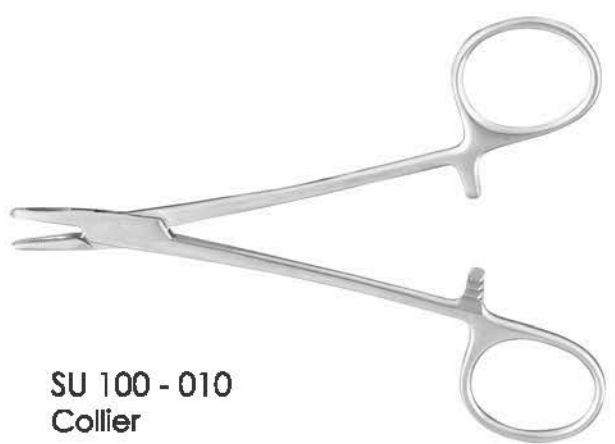

SU 100 - 010
Collier

1 12.5 cm

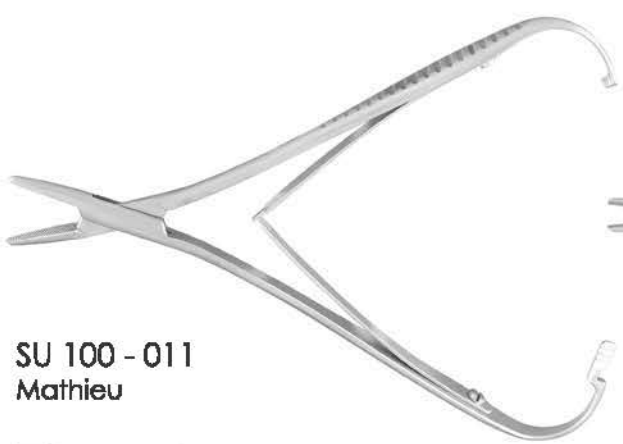

SU 100 - 011
Mathieu

1 14.0 cm
2 17.0 cm
3 20.0 cm



SU 100 - 012
Castraviejo with lock

1	14.0 cm	Straight	With lock
2	14.0 cm	Straight	Without lock
3	14.0 cm	Straight	With lock
4	14.0 cm	Straight	Without lock



SU 100 - 013
Mayo Operating Scissors

1	Straight	14.5 cm	Curved	5
2	Straight	16.0 cm	Curved	6
3	Straight	18.0 cm	Curved	7
4	Straight	20.0 cm	Curved	8



SU 100 - 014
Metzenbaum Scissors

1	Straight	14.5 cm	Curved	4
2	Straight	15.0 cm	Curved	5
3	Straight	18.0 cm	Curved	6

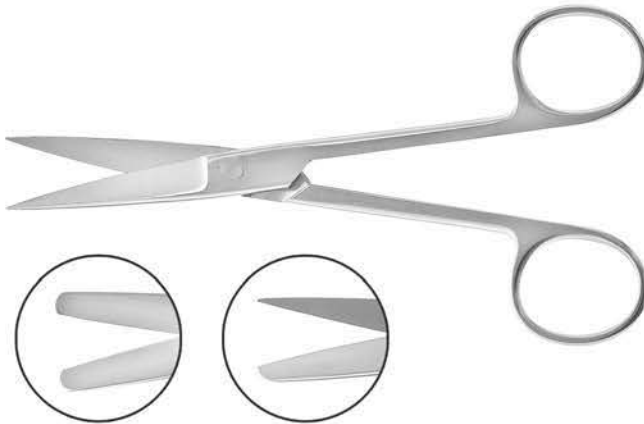

SU 100 - 015
Standard Operating Scissors

1	Sharp/Sharp	Straight	12.5 cm	Curved	13
2	Sharp/Sharp	Straight	14.0 cm	Curved	14
3	Sharp/Sharp	Straight	15.0 cm	Curved	15
4	Sharp/Sharp	Straight	16.0 cm	Curved	16
5	Sharp/Blunt	Straight	12.5 cm	Curved	17
6	Sharp/Blunt	Straight	14.0 cm	Curved	18
7	Sharp/Blunt	Straight	15.0 cm	Curved	19
8	Sharp/Blunt	Straight	16.0 cm	Curved	20
9	Blunt/Blunt	Straight	12.5 cm	Curved	21
10	Blunt/Blunt	Straight	14.0 cm	Curved	22
11	Blunt/Blunt	Straight	15.0 cm	Curved	23
12	Blunt/Blunt	Straight	16.0 cm	Curved	24



SU 100 - 016
Iris Scissors

1	Straight	11.5 cm	Curved	2
---	----------	---------	--------	---



SU 100 - 017
Kilner Scissors

1	Straight	13.0 cm	Curved	2
---	----------	---------	--------	---



SU 100 - 018
Iris - Plastic Handle

1	Straight	11.5 cm
---	----------	---------

SCISSORS

EIBOR Medical

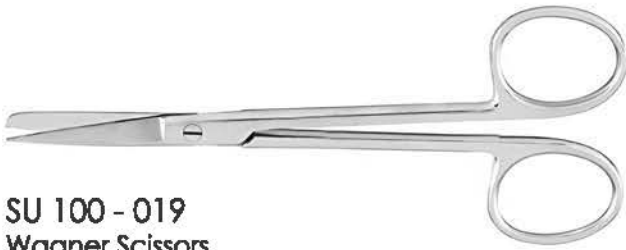

SU 100 - 019
Wagner Scissors

1 Straight 12.5 cm Curved 2



SU 100 - 020
Health Scissors

1 Straight 16.0 cm Curved 2



SU 100 - 021
Castroviejo Scissors

1 Sharp/Sharp Curved 10.0 cm
2 Blunt/Blunt Curved 10.0 cm



SU 100 - 022
Universal Wire Cutting

1 12.0 cm Curved



SU 100 - 023
Spencer - Ligature Scissors

1 9.0 cm Straight



SU 100 - 024
Littauer Stich Scissors

1 9.0 cm
2 13.0 cm
3 14.0 cm

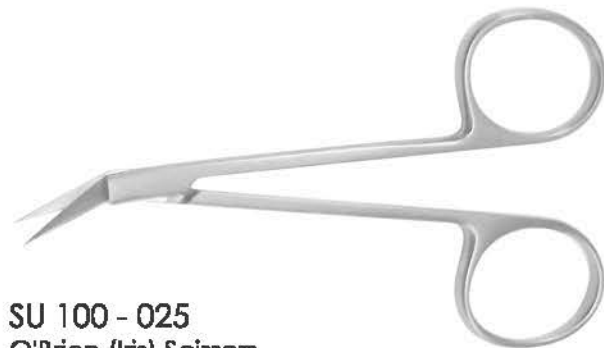

SU 100 - 025
O'Brien (Iris) Scissors

1 9.0 cm Angled

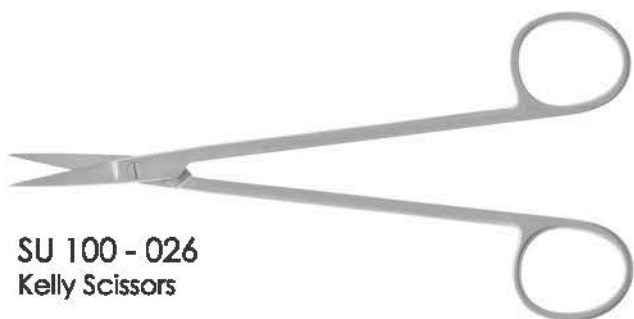

SU 100 - 026
Kelly Scissors

1	Straight	16.0 cm	Curved	3
2	Straight	18.0 cm	Curved	4



SU 100 - 027
Braun Stadler Scissors

1	14.0 cm
2	22.0 cm



SU 100 - 028
Umbilical Cord - Mod. USA

1	10.5 cm
---	---------



SU 100 - 029
Busch Scissors

1	16.0 cm
---	---------



SU 100 - 030
Bebe Ligature Scissor

1	Straight	10.0 cm	Curved	3
2	Straight	12.0 cm	Curved	4



SU 100 - 031
Ward Scissors

1	20.0 cm
---	---------

SCISSORS & TONGUE DEPRESSOR

EIBOR Medical



SU 100 - 032
Plastic Universal Scissors

- 1 16.0 cm
 - 2 19.0 cm
- [Autoclavable]
[Colour Coded Handles]
[Several Colours Available]



SU 100 - 033
Plastic Utility Scissor

- 1 11.5 cm
- [Autoclavable]
[Colour Coded Plastic Handles]
[Several Colours Available]



SU 100 - 034
Tongue Depressor

- 1 17.0 cm



SU 100 - 035
Lister Bandage Scissors

- 1 9.0 cm
- 2 14.0 cm
- 3 18.0 cm



SU 100 - 036
Cuticle Scissors

- 1 Straight 10.0 cm
- 2 Curved



SU 100 - 037
Nail Scissors

- 1 Straight 9.0 cm
- 2 Curved



SU 100 - 038
Dressing Forceps

1	Standard	10.5 cm	Fine	7
2	Standard	11.5 cm	Fine	8
3	Standard	13.0 cm	Fine	9
4	Standard	14.0 cm	Fine	10
5	Standard	16.0 cm	Fine	11
6	Standard	18.0 cm	Fine	12



SU 100 - 040
McIndoe Forceps - Serrated

1	15.0 cm
---	---------



SU 100 - 042
Turnover End Forceps - Serrated

1	13.0 cm	2	15.0 cm
---	---------	---	---------



SU 100 - 044
Tissue Forceps

1	1x2 Teeth	12.5 cm	2x3 Teeth	5
2	1x2 Teeth	14.0 cm	2x3 Teeth	6
3	1x2 Teeth	16.0 cm	2x3 Teeth	7
4	1x2 Teeth	18.0 cm	2x3 Teeth	8



SU 100 - 046
Adson Brown Forceps

1	12.0 cm
---	---------



SU 100 - 039
Adson Forceps - Serrated

1	Standard	12.0 cm
2	Standard	15.0 cm



SU 100 - 041
Potts Smith Forceps - Serrated

1	18.0 cm
2	21.0 cm



SU 100 - 043
Semken Forceps - Serrated

1	12.5 cm
2	15.0 cm



SU 100 - 045
Adson Tissue Forceps

1	Standard 1x2 Teeth	12.0 cm	Fine 1x2 Teeth	3
2	Standard 1x2 Teeth	15.0 cm	Fine 1x2 Teeth	4



SU 100 - 047
Treves Forceps

1	1x2 Teeth	13.0 cm
2	1x2 Teeth	15.0 cm



TISSUE FORCEPS

EIBOR Medical



SU 100 - 048
Allis Tissue Forceps

- 1 3x4 Teeth 15.0 cm
- 2 3x4 Teeth 18.0 cm



SU 100 - 049
Babcock Forceps

- 1 16.0 cm



SU 100 - 050 
Bonney Forceps

- 1 1x2 Teeth 18.0 cm
- 2 2x3 Teeth 18.0 cm



SU 100 - 051 
Gillies Forceps

- 1 1x2 Teeth 15.0 cm



SU 100 - 052 
Lane Forceps

- 1 1x2 Teeth 14.5 cm



SU 100 - 053 
Potts Smith Forceps

- 1 1x2 Teeth 18.0 cm



SU 100 - 054 
Ferris Smith Forceps

- 1 1x2 Teeth 18.0 cm
- 2 2x3 Teeth 18.0 cm



SU 100 - 055 
Waugh Forceps

- 1 1x2 Teeth 20.0 cm



SU 100 - 056 
Semken Forceps

- 1 1x2 Teeth 12.5 cm
- 2 1x2 Teeth 15.0 cm

SPLINTER, JEWELER, AURAL DRESSING FORCEPS



SU 100 - 057
Fellchenfeld Splinter Forceps

- 1 9.0 cm
- 2 11.5 cm



SU 100 - 058
Pointed Tip Splinter Forceps

- 1 9.0 cm
- 2 12.5 cm

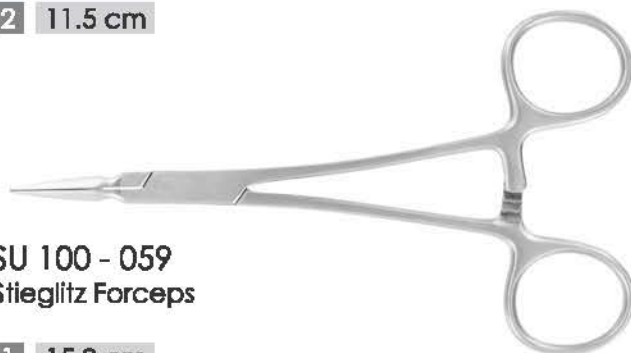

SU 100 - 059
Stieglitz Forceps

- 1 15.0 cm



SU 100 - 060
Hunter Forceps

- 1 Straight 10.0 cm Curved 2



SU 100 - 062
Forceps with Magnifier

- 1 Straight 10.0 cm
- 2 Curved 10.0 cm



SU 100 - 061
Jewellers Forceps

- 1 12.5 cm Fine Point



SU 100 - 063
Jewellers Forceps

- 1 11.5 cm Fine Point

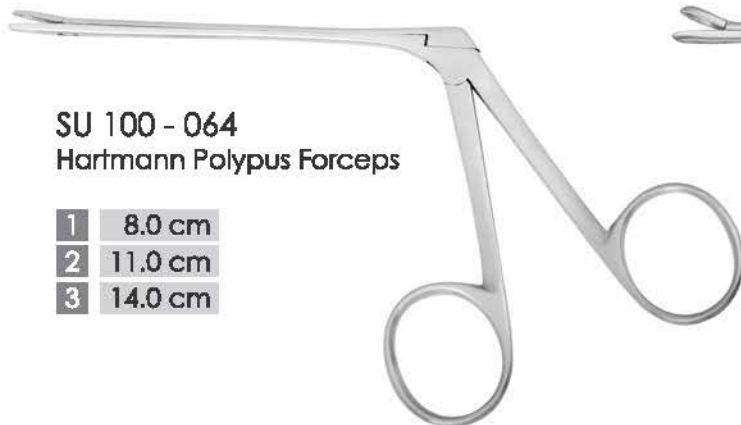

SU 100 - 064
Hartmann Polypus Forceps

- 1 8.0 cm
- 2 11.0 cm
- 3 14.0 cm



SU 100 - 065
McGee Ear Forceps

- 1 8.0 cm
- 2 11.0 cm

UTERINE, CILIA FORCEPS

EIBOR Medical



SU 100 - 066
Tilley Aural Dressing Forceps

1 14.0 cm



SU 100 - 067
Magill Catheter Forceps

1 Infant 15.0 cm
1 Child 20.0 cm
1 Adult 25.0 cm



SU 100 - 068
Lister Sinus Forceps

1 13.0 cm
2 16.0 cm



SU 100 - 069
Beer Cilia Forceps

1 9.0 cm



SU 100 - 070
Jansen Aural Dressing Forceps

1 20.0 cm



SU 100 - 071
Troeltsch Aural Dressing Forceps

1 13.0 cm
2 18.0 cm

UTERINE, TUBING, SPONGE HOLDING FORCEPS



SU 100 - 072
Tubing Clamp Forceps

- 1 16.0 cm
- 2 18.0 cm



SU 100 - 073
Foerster Swab Forceps

- | | | | | |
|---|----------|---------|--------|---|
| 1 | Straight | 18.0 cm | Curved | 4 |
| 2 | Straight | 20.0 cm | Curved | 5 |
| 3 | Straight | 25.0 cm | Curved | 6 |

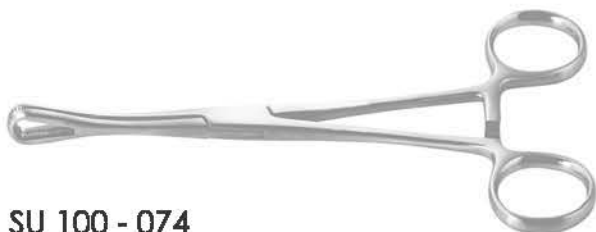

SU 100 - 074
Rampley Forceps

- 1 18.0 cm
- 2 25.0 cm



SU 100 - 075
Cheatle Sterilizing Forceps

- 1 27.0 cm

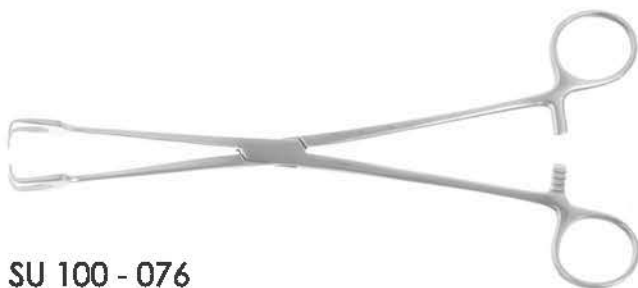

SU 100 - 076
Schroeder Tenaculum Forceps

- 1 25.0 cm 2x2 Teeth



SU 100 - 077
Schroeder Braun Tenaculum Forceps

- 1 25.0 cm

UTERINE, OBSTETRICAL FORCEPS SEPTUM ELEVATOR

EIBOR Medical



SU 100 - 078
Bozeman Forceps

1 26.0 cm Curved



SU 100 - 079
Teale Vulsellum Forceps

1 25.0 cm Curved

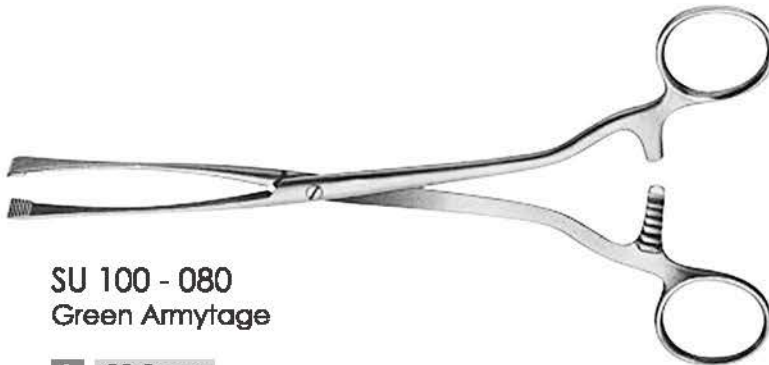

SU 100 - 080
Green Armytage

1 22.0 cm



SU 100 - 081
Freer Elevators

1 Double-End 18.0 cm Sharp/Blunt



SU 100 - 082
Howarth Elevators

1 Double-End 21.5 cm



SU 100 - 083
Simpson-Brown Obstetrical
Forceps

1 36.0 cm

**ARTERY FORCEPS
BULLDOG CLAMPS**



SU 100 - 084
Hartmann Artery Forceps

- | | | | | |
|---|----------------------|---------|--------------------|---|
| 1 | Straight | 10.0 cm | Curved | 3 |
| 2 | Straight - 1x2 Teeth | 10.0 cm | Curved - 1x2 Teeth | 4 |



SU 100 - 085
Spencer-Wells Artery Forceps

- | | | | | |
|---|----------|---------|--------|---|
| 1 | Straight | 13.0 cm | Curved | 4 |
| 2 | Straight | 15.0 cm | Curved | 5 |
| 3 | Straight | 18.0 cm | Curved | 6 |



SU 100 - 086
Crile Artery Forceps

- | | | | | |
|---|----------------------|---------|--------------------|---|
| 1 | Straight | 14.0 cm | Curved | 5 |
| 2 | Straight | 16.0 cm | Curved | 6 |
| 3 | Straight - 1x2 Teeth | 14.0 cm | Curved - 1x2 Teeth | 7 |
| 4 | Straight - 1x2 Teeth | 16.0 cm | Curved - 1x2 Teeth | 8 |



SU 100 - 087
Halstead Mosquito Artery Forceps

- | | | | | |
|---|----------------------|---------|--------------------|----|
| 1 | Straight | 12.5 cm | Curved | 7 |
| 2 | Straight | 14.0 cm | Curved | 8 |
| 3 | Straight | 18.0 cm | Curved | 9 |
| 4 | Straight - 1x2 Teeth | 12.5 cm | Curved - 1x2 Teeth | 10 |
| 5 | Straight - 1x2 Teeth | 14.0 cm | Curved - 1x2 Teeth | 11 |
| 6 | Straight - 1x2 Teeth | 18.0 cm | Curved - 1x2 Teeth | 12 |



SU 100 - 088
Kelly Artery Forceps

- | | | | | |
|---|----------|---------|--------|---|
| 1 | Straight | 14.0 cm | Curved | 3 |
| 2 | Straight | 16.0 cm | Curved | 4 |



SU 100 - 089
Dieffenbach Bulldog Clamps

- | | | | | |
|---|----------|--------|--------|---|
| 1 | Straight | 3.5 cm | Curved | 3 |
| 2 | Straight | 5.0 cm | Curved | 4 |



SU 100 - 090
Mixer Artery Forceps

- | | | |
|---|---------|--------|
| 1 | 18.0 cm | Curved |
|---|---------|--------|

ARTERY FORCEPS

EIBOR Medical



SU 100 - 091
Rochester-Carmalt Forceps

1	Straight	16.0 cm	Curved	3
2	Straight	20.0 cm	Curved	4



SU 100 - 092
Rochester-Pean Forceps

1	Straight	14.0 cm	Curved	5
2	Straight	16.0 cm	Curved	6
3	Straight	18.0 cm	Curved	7
4	Straight	20.0 cm	Curved	8

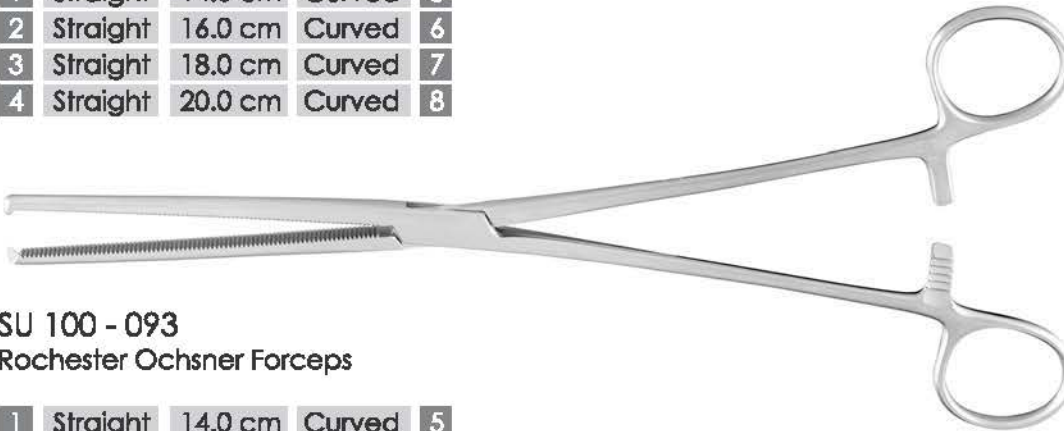

SU 100 - 093
Rochester Ochsner Forceps

1	Straight	14.0 cm	Curved	5
2	Straight	16.0 cm	Curved	6
3	Straight	18.0 cm	Curved	7
4	Straight	20.0 cm	Curved	8



SU 100 - 094
Lahay Artery Forceps

1	23.0 cm	Curved
---	---------	--------



SU 100 - 095
DeBakey Atrauma Forceps

1	16.0 cm
2	20.0 cm



SU 100 - 096
Willinger Curette

1	00 + 0	14.0cm	Double End
2	0 + 1	14.0cm	Double End
3	1 + 2	14.0cm	Double End



SU 100 - 097
Volkman Curette

1	000	17.0cm	Single End
2	00	17.0cm	Single End
3	0	17.0cm	Single End
4	2	17.0cm	Single End
5	3	17.0cm	Single End



SU 100 - 098
Volkman Curette

1	17.0cm	Double End
---	--------	------------



SU 100 - 099
Martini Curette

1	00 + 0	14.0cm	Double End
2	0 + 1	14.0cm	Double End
3	1 + 2	14.0cm	Double End
4	2 + 3	14.0cm	Double End



SU 100 - 100
Meyhoefer Curette

1	1 mm	13.0cm	Single End
2	2 mm	13.0cm	Single End
3	3.5 mm	13.0cm	Single End
4	4.5 mm	13.0cm	Single End



SU 100 - 101
Buck Curette

1	Straight	16.5 cm	Size 00	Sharp	11
2	Straight	16.5 cm	Size 0	Sharp	12
3	Straight	16.5 cm	Size 1	Sharp	13
4	Straight	16.5 cm	Size 00	Blunt	14
5	Straight	16.5 cm	Size 0	Blunt	15
6	Straight	16.5 cm	Size 1	Blunt	16
7	Straight	16.5 cm	Size 2	Blunt	17
8	Straight	16.5 cm	Size 3	Blunt	18
9	Curved	16.0 cm	Size 00	Blunt	19
10	Curved	16.0 cm	Size 1	Blunt	20



SU 100 - 102
Sims Uterine Curette

1	5 mm	26.0cm	Blunt
2	6 mm	26.0cm	Blunt
3	7 mm	26.0cm	Blunt
4	8 mm	26.0cm	Blunt
5	12 mm	26.0cm	Blunt

SPECULUM

EIBOR Medical

SU 100 - 103
Graves Vaginal Speculum

1	75 x 20 mm	Small
2	95 x 35 mm	Medium
3	115 x 35 mm	Large



SU 100 - 104
CUSCO Vaginal Speculum

1	75 x 32 mm	Small
2	85 x 35 mm	Medium
3	100 x 35 mm	Large



SU 100 - 105
Ear Speculum

1	Metal	2 mm	Plastic	6
2	Metal	3 mm	Plastic	7
3	Metal	4 mm	Plastic	8
4	Metal	5 mm	Plastic	9
5	Metal	6 mm	Plastic	10

SU 100 - 106
Killian Nasal Specula

1	13.0cm	35mm
2	13.0cm	50mm
3	13.0cm	75mm
4	13.0cm	90mm

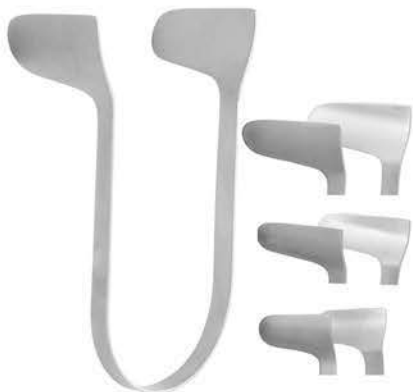

SU 100 - 107
Thudichum Nasal Specula

1	18 x 8 mm
2	20 x 10 mm
3	22 x 12 mm
4	24 x 13 mm
5	26 x 13 mm

SU 100 - 108
Sims Vaginal Speculum

1	65 x 25 mm	Small
	70 x 30 mm	
2	70 x 30 mm	Medium
	70 x 35 mm	
3	85 x 35 mm	Large
	90 x 40 mm	





SU 100 - 109
No. 3 Scalpel Handle

1 Solid



SU 100 - 110
No. 3L Scalpel Handle

1 Solid Straight



SU 100 - 111
No. 4 Scalpel Handle

1 Solid



SU 100 - 112
No. 4L Scalpel Handle

1 Solid Straight



SU 100 - 113
No. 7 Scalpel Handle

1 Solid Straight



SU 100 - 114
Scalpel Handle Plastic Handle

1 Solid Straight

Plastic Handle Scalpels can be made compatible with different blades sizes.

RETRACTORS

EIBOR Medical



SU 100 - 115
Weitlaner Retractors

1	2 x 3 Prongs	10.5 cm	Sharp
2	2 x 3 Prongs	10.5 cm	Blunt
3	3 x 4 Prongs	14.0 cm	Sharp
4	3 x 4 Prongs	14.0 cm	Blunt



SU 100 - 116
Mollison Retractors

1	4 x 4 Prongs	15.0 cm	Sharp
---	--------------	---------	-------



SU 100 - 117
Gelpi Retractors

1	1 x 1 Prongs	11.0 cm	Sharp
---	--------------	---------	-------

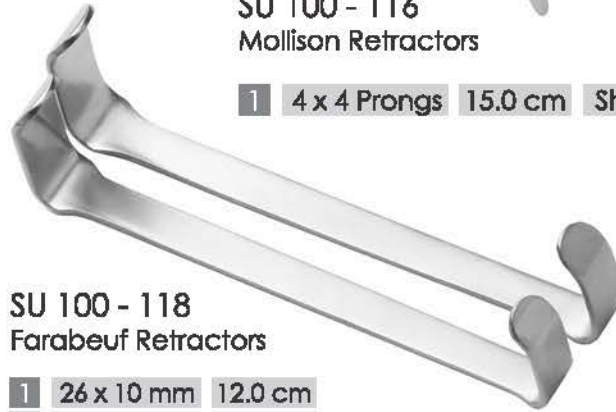

SU 100 - 118
Farabeuf Retractors

1	26 x 10 mm	12.0 cm
	30 x 13 mm	
2	30 x 10 mm	12.0 cm
	34 x 13 mm	



SU 100 - 119
Senn-Muller - Cat's Paw Retractor

1	Sharp	16.0 cm	Blunt
---	-------	---------	-------



SU 100 - 120
Delicate Retractor

1	Sharp	16.0 cm	2 Prongs
2	Sharp	16.0 cm	3 Prongs
3	Blunt	16.0 cm	2 Prongs
4	Blunt	16.0 cm	3 Prongs



SU 100 - 121
Langenbeck Retractors

1	30 x 11 mm	22.0 cm
2	30 x 14 mm	22.0 cm
3	30 x 16 mm	22.0 cm
4	40 x 11 mm	22.0 cm



SU 100 - 122
Volkman Retractors

1	Sharp	1 Prongs	21.5 cm	Blunt	6
2	Sharp	2 Prongs	21.5 cm	Blunt	7
3	Sharp	3 Prongs	21.5 cm	Blunt	8
4	Sharp	4 Prongs	21.5 cm	Blunt	9
5	Sharp	5 Prongs	21.5 cm	Blunt	10



SU 100 - 123
Kliner Hooks

1 2.5 mm 16.0 cm



SU 100 - 124
Gillies Skin Hooks

1 4 mm 18.0 cm Sharp
2 4 mm 18.0 cm Blunt



SU 100 - 125
Joseph Skin Hooks

1 2 mm 16.0 cm Sharp
2 5 mm 16.0 cm Sharp



SU 100 - 126
Myringotomy Knife

1 Straight 16.0 cm Plastic Handle
2 Curved 16.0 cm Plastic Handle



SU 100 - 127
Cawthorne Needle

1 16.0 cm



SU 100 - 128
Cotton Applicator

1 23.0 cm



SU 100 - 129
Jobson Horne Probe

1 12.0 cm
2 18.0 cm

PODIATRY TOOLS

EIBOR Medical



SU 100 - 130
Single Leaf without Lock

10.5 cm

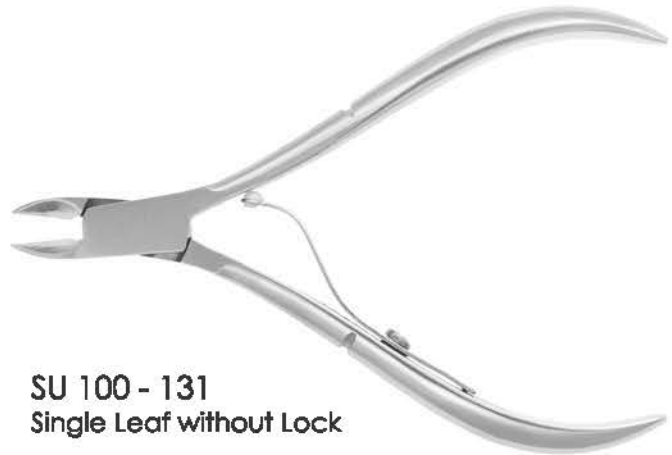

SU 100 - 131
Single Leaf without Lock

10.5 cm



SU 100 - 132
Double Leaf with Lock

13.0 cm



SU 100 - 133
Double Leaf with Lock

13.0 cm



SU 100 - 134
Cuticle Nipper

10.5 cm



SU 100 - 135
Turnbull

11.5 cm



SU 100 - 136
Nail File

1 11.0 cm
2 13.0 cm

SU 100 - 137
Poole Suction Tubes



1	10 mm .	22.0 cm	Straight
2	8 mm	22.0 cm	Curved

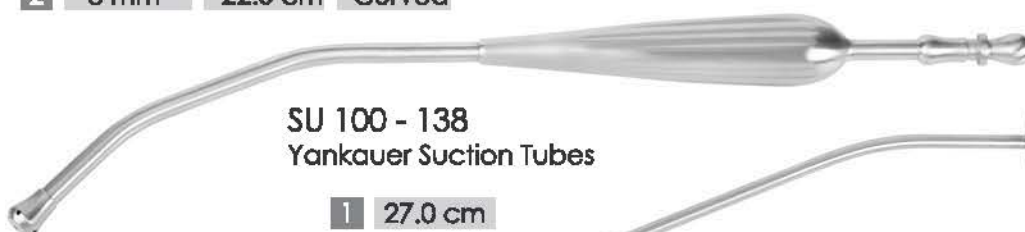

SU 100 - 138
Yankauer Suction Tubes

1	27.0 cm
---	---------



SU 100 - 139
Frazier Suction Tubes

1	6	19.0 cm
2	8	19.0 cm
3	10	19.0 cm
4	12	19.0 cm



SU 100 - 140
Adson Suction Tubes

1	4	21.0 cm
---	---	---------



SU 100 - 141
Metal Catheter

1	10 F.G	15.5 cm
2	12 F.G	15.5 cm
3	14 F.G	15.5 cm



SU 100 - 142
Baron Suction Tubes

1	3 F.G	14.0 cm
2	5 F.G	14.0 cm
3	7 F.G	14.0 cm



SU 100 - 143
Pediatric Suction Tubes

1	27.0 cm
---	---------



SU 100 - 144
Spackman Cannula

1	36.0 cm
---	---------

BIOPSY FORCEPS & DILATORS

EIBOR Medical

SU 100 - 145
Tischler Biopsy Forceps

- 1 7 x 3 mm Jaw 25.0 cm Shaft
- 2 4.2 x 2.3 mm Jaw 21.0 cm Shaft

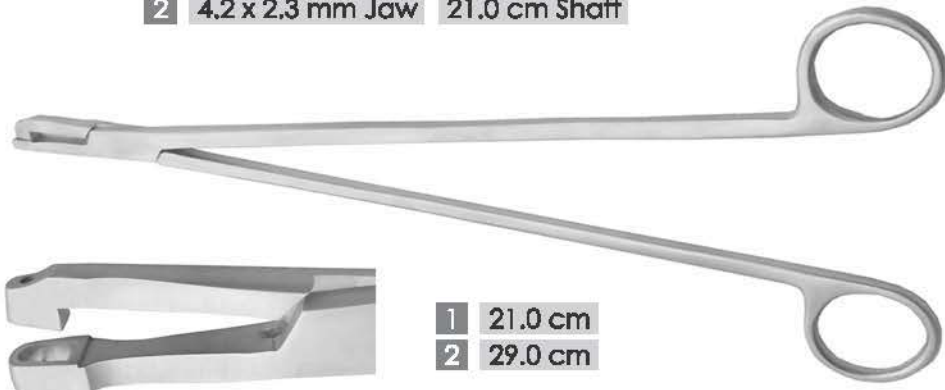

- 1 21.0 cm
- 2 29.0 cm

SU 100 - 146
Schubert Biopsy Forceps

SU 100 - 147
Hegar Dilators - Double End

Set of 12

- | | | | |
|---|----------|----|----------|
| 1 | 1/2 mm | 7 | 13/14 mm |
| 2 | 3/4 mm | 8 | 15/16 mm |
| 3 | 5/6 mm | 9 | 17/18 mm |
| 4 | 7/8 mm | 10 | 19/20 mm |
| 5 | 9/10 mm | 11 | 21/22 mm |
| 6 | 11/12 mm | 12 | 23/24 mm |
| | | 13 | 25/26 mm |



SU 100 - 148
Hegar Dilators - Single End

Set of 12

- | | | | |
|---|------|----|-------|
| 1 | 3 mm | 7 | 9 mm |
| 2 | 4 mm | 8 | 10 mm |
| 3 | 5 mm | 9 | 11 mm |
| 4 | 6 mm | 10 | 12 mm |
| 5 | 7 mm | 11 | 13 mm |
| 6 | 8 mm | 12 | 14 mm |

SU 100 - 149
Sims Uterine Sounds

- 1 32.0 cm Malleable - Silver
- 2 32.0 cm Rigid - Steel





SU 100 - 150
Laborde Trachea Dilators

1 14.0 cm

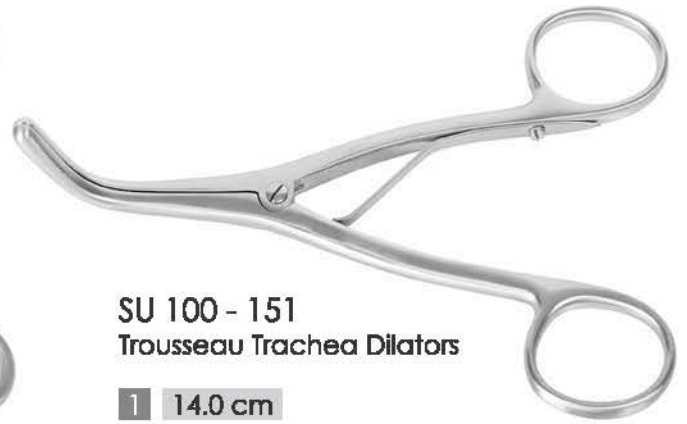

SU 100 - 151
Trousseau Trachea Dilators

1 14.0 cm



SU 100 - 152
Backhaus Towel Clamp

1 9.0 cm
2 11.0 cm
3 14.0 cm



SU 100 - 153
Cross Action Towel Clamp

1 8.0 cm



SU 100 - 154
Ball & Socket Towel Clamp

1 9.0 cm
2 13.0 cm



SU 100 - 155
Lorna Towel Clamp

1 14.0 cm

LARYNGEAL MIRRORS, HAND DRILL & WIRE SAW

EIBOR Medical

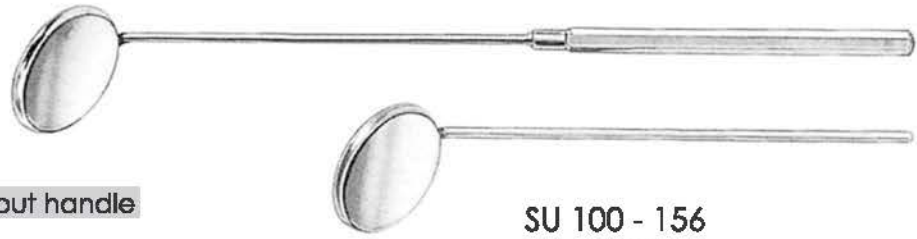

with handle

without handle

1	8 mm	13
2	10 mm	14
3	12 mm	15
4	14 mm	16
5	16 mm	17
6	18 mm	18
7	20 mm	19
8	22 mm	20
9	24 mm	21
10	26 mm	22
11	28 mm	23
12	30 mm	24

SU 100 - 156
Mirror & Handle



SU 100 - 157
Hudson Hand Drill
27.0 cm



SU 100 - 158
Cushing
14 mm



SU 100 - 159
9 mm



SU 100 - 160
14 mm



SU 100 - 161
16 mm

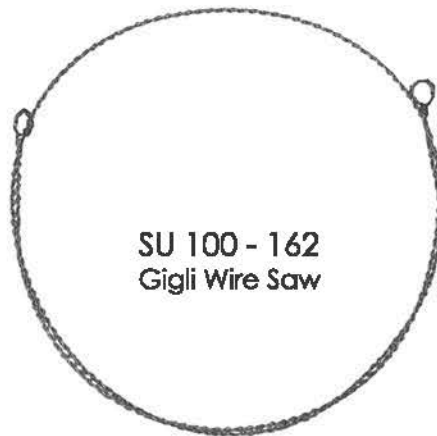

SU 100 - 162
Gigli Wire Saw

1	30 cm
2	40 cm
3	50 cm
4	60 cm
5	70 cm



SU 100 - 163
Gigli Saw Handle



SU 100 - 164
Directors

- 1 13 cm
- 2 14 cm
- 3 16 cm



SU 100 - 165
Directors with Tip
14 cm

- 1 3.3 mm 14 cm



SU 100 - 166
Probes

- 1 14.5 cm



SU 100 - 167
Probes Double End
Malleable
3.5 mm

- 1 25 cm
- 2 30 cm



SU 100 - 168
Probes
30 cm

- 1 1.5 cm
- 2 2.0 cm
- 3 2.5 cm



SU 100 - 169
Stacke



SU 100 - 170
Pinard (Wooden)

- 1 15 cm



SU 100 - 171
Pinard (Aluminium)

- 1 15 cm



SU 100 - 172
Pinard (Plastic)

- 1 15 cm

LED LARYNGOSCOPE SET

EIBOR Medical



Handle

1. Single use LED Laryngoscope Handles
2. Easy handling and grip
3. Cost Effective
4. Reduce risk of contamination
5. Fits all size of blades

Blades

1. Disposable fiber optic LED blades
2. Metal construction, Japanese grade steel
3. Anti-glare bright LED source
4. Colour coded for easy identification
5. Excellent tensile strength

Macintosh

SU 100 - 176
Mac 4



SU 100 - 177
Mac 3



SU 100 - 178
Mac 2



SU 100 - 179
Mac 1



Miller

SU 100 - 180
Miller 3



SU 100 - 181
Miller 2



SU 100 - 182
Miller 1



SU 100 - 183
Miller 0





Full Dual Rings



Half Dual Rings



Half Rings

All instruments displayed in this catalogue are available in colour coding as shown.

1. Easy identification
2. Biologically safe
3. Sterile safe
4. Different colour available
5. Options of paint and powder coating



Standard



Standard



Standard



Full Dual Rings



Half Dual Rings



Half Rings

